

> Enkelt eller dobbel læg

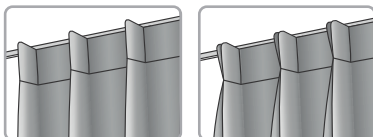

Kontrollér at gardinhæfterne er justeret i samme højde.

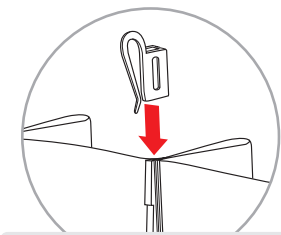
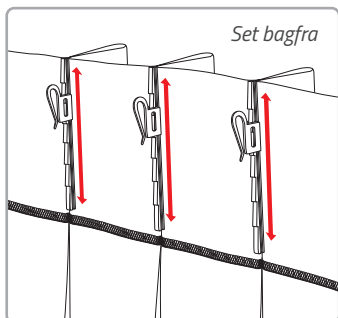

Flyt hæfterne fra top til bund for at justere gardinets højde.

Tip! For lige placering af alle hæfter, tæl klikkene!

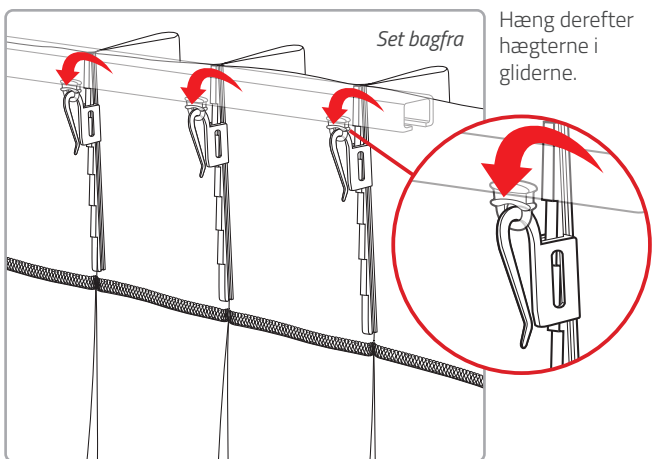

Hæng derefter hæfterne i gliderne.

> Wave fold

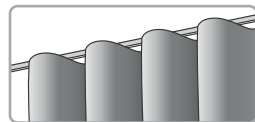

Placér de medfølgende glidere i skinnen.

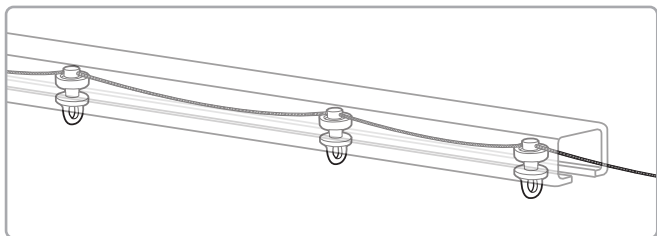

Fastgør den medfølgende frontskinne til begge ender af gardinet.

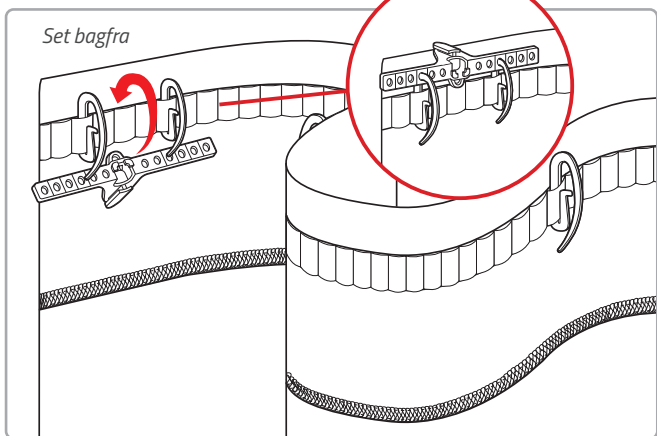

“Klik” derefter den forreste glider på den yderste glider.

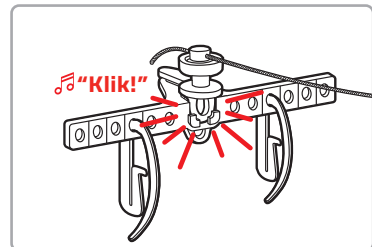
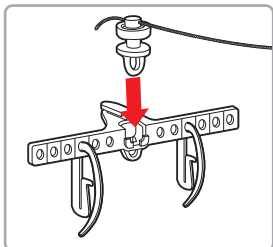

Arbejd resten af krogene ind i gliderne.

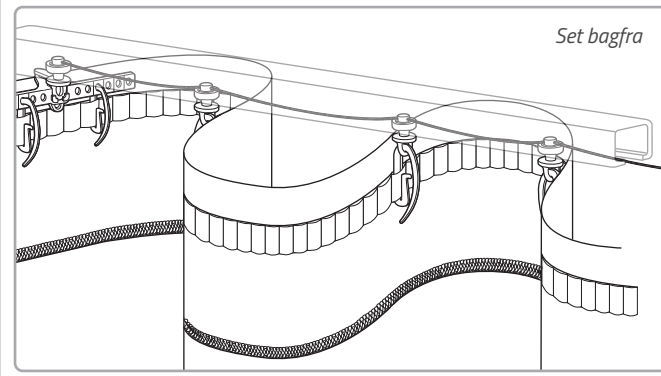

! OBS! Installér samt brug kun de medfølgende dele i henhold til vejledningen.

